

Lumistar Luminaire ESL 51-LED

ESL 51-LED-HK: with bracket for SW I (wiper unit)

ESL 51-LED-KS: with hinged bracket for general use

ESL 51-LED-B: special sterile version for flange attachment for fitting over flanges, collars, etc.

- **Ideal combination of flush design and smooth surface:**

This sight glass luminaire is designed for mounting on sight glass fittings in universal applications. It is practical either in combined sight and light ports (single-flange version) or with separate ports (two-flange version). Integrated fastening clamp enables attachment to Lumiglas wiper unit SW I.

- **Compact design, powerful light output:**

Glare-free illumination; fits circular sight glass fittings similar to DIN 28120 / DIN 28121 as well as screwed sight glass fittings similar to DIN 11851.

- **Applications in the chemical, pharmaceutical, biogas and food processing industries:**

For illuminating the interior of vessels, tanks, agitators, silos and other generally closed containers and reactors and also in visual flow indicators in non-explosive environments.

- **Protection class:**

Dust-tight and water jet-proof,
IP 65 acc. to EN 60 529 / DIN VDE 0470 part 1

- **Operating conditions:**

Independent of vacuum/pressure in the vessel. Under no circumstances should a sight glass luminaire be used as a substitute for the cover flange or instead of the complete sight glass flange assembly, or on its own to close a vessel port.

- **Caution:**

Do not look into light – Danger of impaired eyesight!

- **Maximum admissible ambient temperature at the cable gland:**
50°C

- **Straightforward installation using special attachment, ensuring convenience of use:**

The luminaire is fixed to the mating flange by a hinged bracket in the case of circular sight glass fittings and visual flow indicators. With screw-type sight glass fittings, it is fastened to the groove nut.

- **Lumistar ESL 51-LED luminaires fit the following nominal sizes:**

- Circular sight glass fittings similar to DIN 28120: from DN 25
- Circular sight glass fittings similar to DIN 28121: from DN 40
- Visual flow indicators: from DN 25
- Screw-type sight glass fittings similar to DIN 11851: from DN 40

- **Operating voltage:**

24 V AC/DC – 2.5 W
Colour temperature: 5000 K
Luminous flux: 180 lm

- **Reflected beam angle:** 18°

- **Transformers or AC/DC converters** for on-site installation or for installing in a control cabinet are available on request.

(Transformer: 230 V AC - 24 V AC)
(AC/DC converter: 230 V AC - 24 V DC)

CE

3755.361 c



Lumistar luminaire ESL 51-LED-HK installed on a screwed sight glass fitting equipped with Lumiglas wiper unit SW I



Lumistar luminaire ESL 51-LED-KS adapted to a standard flange

• **Dimensions of Lumistar ESL 51-LED luminaires:**

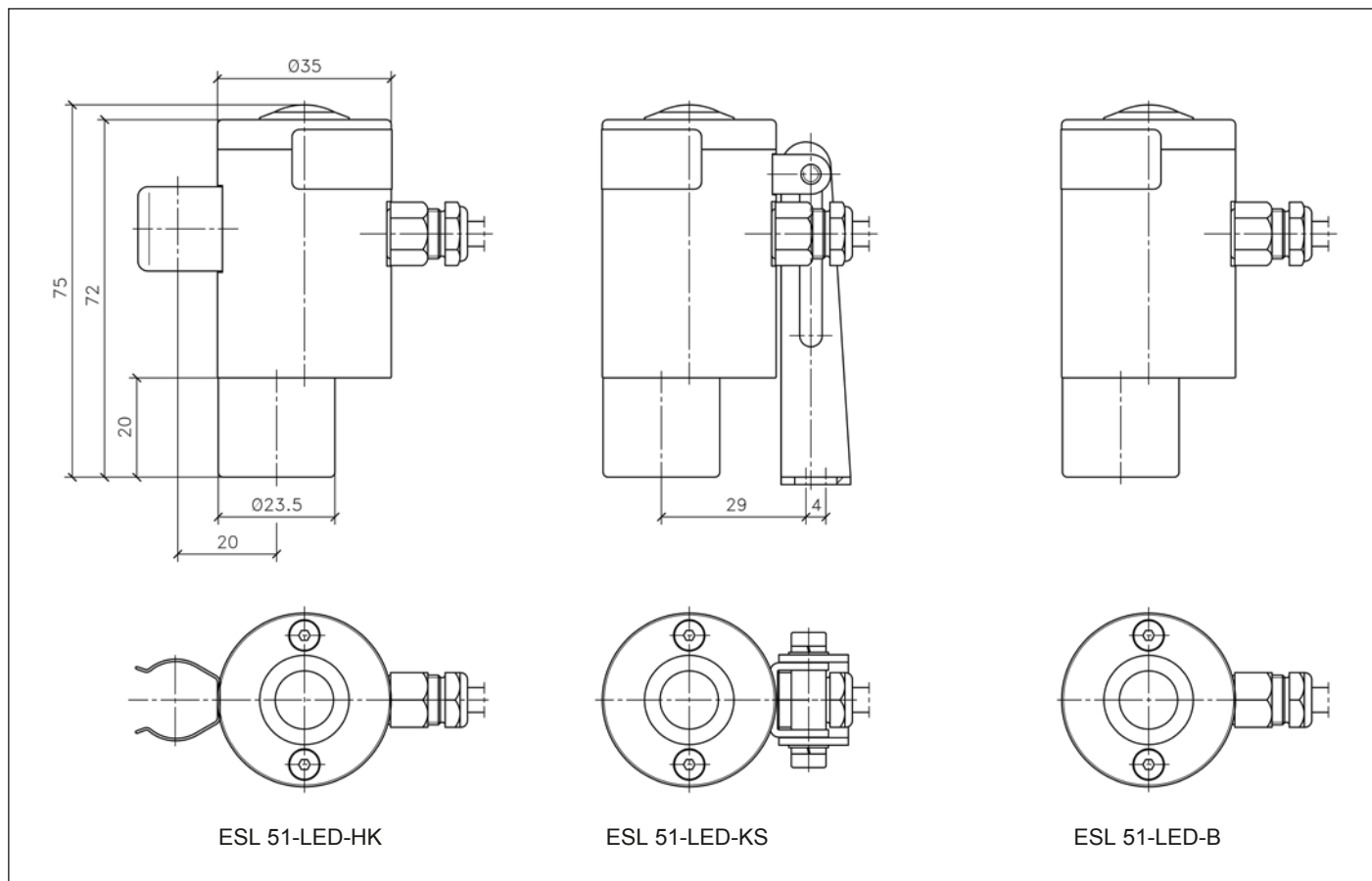

• **Description and materials:**

- Body and head of luminaire: Stainless steel 1.4404
- Fastening elements: Stainless steel

- Connecting cable: 3 m (3 x 0.5 mm²) factory-fitted, other lengths on request
- Weight: 0.3 kg

• **Connecting data:**

Lumistar ESL 51-LED luminaires

Item	Type	Voltage/wattage	Pushbutton	Fastening element	Part No.
1	ESL 51-LED-HK	24 V AC/DC - 2.5 W	without	Clamp attachment	3541.303.00
2	ESL 51-LED-HK	24 V AC/DC - 2.5 W	with	Clamp attachment	3541.306.00
3	ESL 51-LED-KS	24 V AC/DC - 2.5 W	without	Hinged bracket	3541.304.00
4	ESL 51-LED-KS	24 V AC/DC - 2.5 W	with	Hinged bracket	3541.307.00
5	ESL 51-LED-B	24 V AC/DC - 2,5 W	without	Flange adapter	3541.305.00
6	ESL 51-LED-B	24 V AC/DC - 2.5 W	with	Flange adapter	3541.308.00

• **Order data:** e.g.

Lumistar luminaire ESL 51-LED-HK, with pushbutton, clamp fastening element, part no. 3541.306.00