



Kiegészítők Gömbcsuklók / Közdarab

Gömbcsuklók

A Lechler gömbcsuklók lehetővé teszik a zajszintcsökkentett lapossugarú és pontsugarú levegőfúvókák irányba állítását 30°-os szögben minden irányban körkörösén. Nincs kopó tömítés. Hosszú problémamentes élettartam, gyakori állítgatás esetén is.

$p_{max} = 25 \text{ bar}$

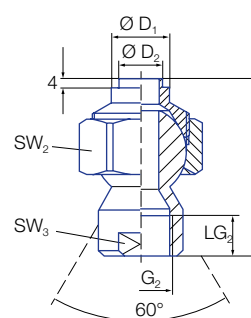
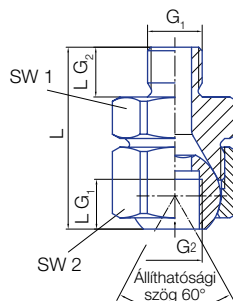
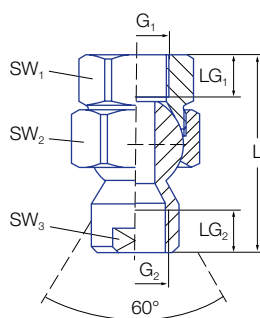

Csatlakozás	Cikkszám					Méretek										Tömeg (réz)
	Típus	Anyagszám			Kód	D ₁	D ₂	G ₁ ISO 228	G ₂ ISO 228	L _{G1} [mm]	L _{G2} [mm]	L [mm]	SW ₁	SW ₂	SW ₃	
		16 1.4305 / 1.4571	16 1.4305	30 Réz												
Gömbcsukló menettel	① 092.020	-	○	○	AD	-	-	1/4	1/4	12,0	11,5	60,3	27	27	17	60 g
	① 092.021	-	○	○	AF	-	-	3/8	1/4	12,0	11,5	58,3	27	27	17	80 g
	② 092.024	-	○	○	AC	-	-	1/4A	1/4	12,0	12,0	44,0	27	27	-	140 g
	② 092.030	-	○	○	AE	-	-	3/8A	3/8	12,0	12,0	44,0	27	30	-	160 g
Gömbcsukló hegcsonttal	③ 092.020	○	-	-	SD	20,0	15,0	-	1/4	-	11,5	64,3	-	27	17	60 g
	③ 092.030	○	-	-	SF	22,0	15,0	-	3/8	-	12,0	58,7	-	30	19	80 g

Rendelési példa: Típus 092.020. + Anyagszám 16. + Csatlakozás AD = Cikkszám 092.020.16.AD

Közdarab

095.016.30.14.23.0

Ez a réz közdarab lehetővé teszi a fúvókák csatlakoztatását levegőpisztolyokhoz.

Alkalmazható a következő típusokhoz:

- 600.130
- 600.283
- 600.332
- 600.606
- 600.493
- 600.484
- 600.326
- 544

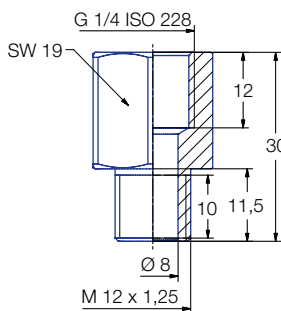



Kiegészítők Szerelőbilincsek / Duplacsonk / Hollander anya

Szerelőbilincsek

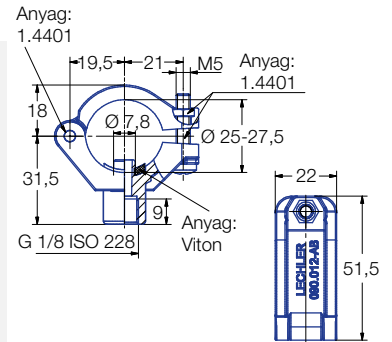
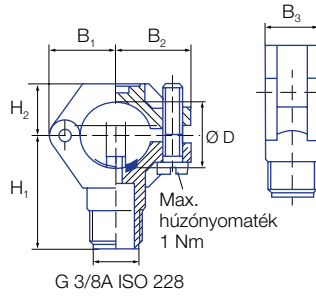

Típus	Cikkszám			Osztály	Méretek [mm]								Tömeg (Poliamid)
	Anyagszám				Cső Ø	D Ø	B _R Ø	B ₁	B ₂	B ₃	H ₁	H ₂	
	51 Poliamid	53 Polipropilén	5E PVDF										
090.053	○	○	○	Anyag: Saválló acél 1.4301	3,8"	16,5-18,0	6,2	19,0	22,0	18,5	34,5	14,5	20 g
090.003	○	○	○		1/2"	20 - 22,0	6,2	21,2	23,8	18,5	36,5	16,5	20 g
090.013	○	○	○		3/4"	25 - 27,5	7,8	24,5	26,5	22,0	39,5	17,5	25 g
090.023	○	○	○		1"	32 - 34,5	10,8	30,0	31,0	22,0	44,0	21,0	32 g
090.033	○	○	○		1 1/4"	40 - 43,0	12,8	34,0	35,5	25,0	48,0	25,0	38 g
090.012	-	-	○		1.4401	3/4"	25 - 27,5	7,8	19,5	21,0	22,0	31,5	18,0

Duplacsonk

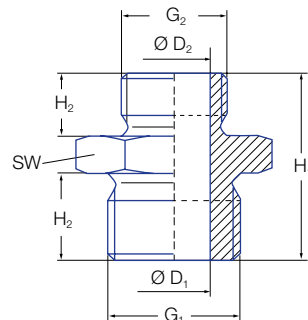

Típus	Cikkszám		Méretek [mm]								Tömeg (réz)
	Anyagszám		G ₁ ISO 228	G ₂ ISO 228	H ₁	H ₂	D ₁	D ₂	SW		
	17 Acél 1.4571	30 Réz									
065.215	○	○	3/8 A	1/4 A	25	10	10	7	22	30 g	
065.211	○	○	3/8 A	3/8 A	25	10	11,5	-	22	25 g	

Hollander anya

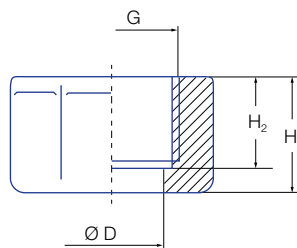
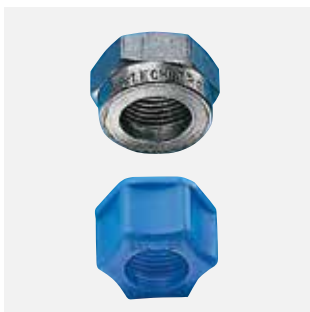

Típus	Cikkszám					Méretek [mm]					Tömeg (réz)
	Anyagszám					G BSPP	H ₁	H ₂	D	SW	
	16 Acél 1.4305	17 Acél 1.4571	30 Réz	56 POM	5E PVDF						
065.200	○	○	○	-	-	3/8	13,0	10,0	12,8	22	25 g
065.200	-	-	-	○	○	3/8	14,5	11,5	12,8	22	25 g